

Our Products

Hoods

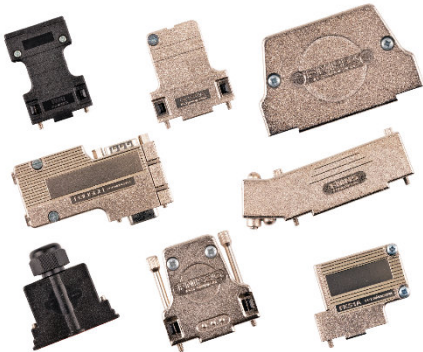

Large Selection of Hoods:

In our wide range, consisting of plastic, metal and metallized hoods, a suitable solution can be found for almost any requirement.

Hoods are available in various shell sizes and designs .

Connectors

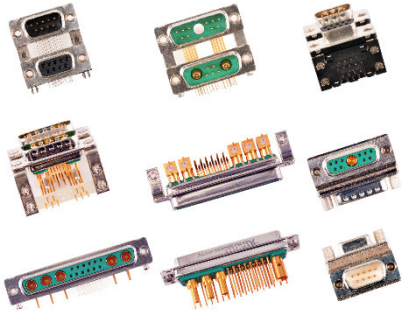

Wide Range of Connectors:

- D-Sub Standard Connectors
- D-Sub Dualport Connectors
- D-Sub Mixed Layout Connectors
- D-Sub Crimp Connectors
- D-Sub Filter Connectors
- D-Sub High Density Connectors
- Connectors according to EN60603-2 (DIN 41612)
- D-Sub Waterproof Connectors IP67
- D-Sub IDC Ribbon Connectors
- Reflow Versions (SMT / THT)

Contacts



A large selection of contacts / connectors

- Also part of our product range:
- High Voltage and High Power Contacts
 - D-Sub and EN60603-2 (DIN 41612) Coaxial Contacts
 - MCX-, SMA-, SMB-, SMC-, MMCX-, F-Connectors
 - Pneumatic Contacts
 - Special Designs

Our Products



Metal Hoods / Plastic Hoods / Waterproof Hoods



Our Products

BUS Interface Connectors



Connectors for Bus Systems Including CAN-Bus:
available:
- Shielded/ metalised and in plastic

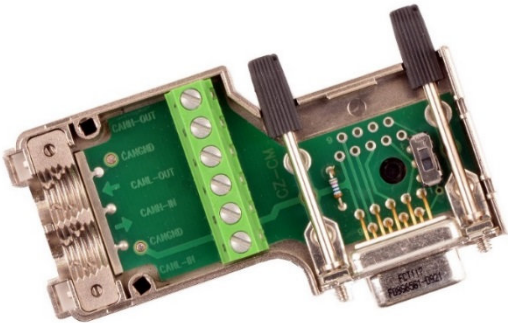

Our Products

Standard D-Sub Miniature Connectors

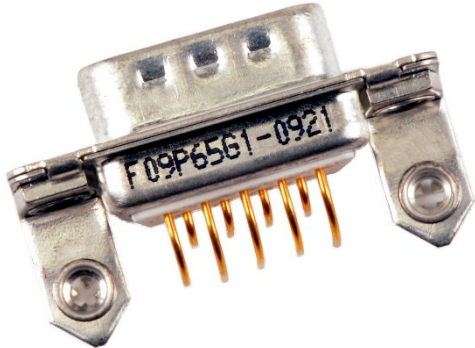

PC Board Mount



IDC Connectors

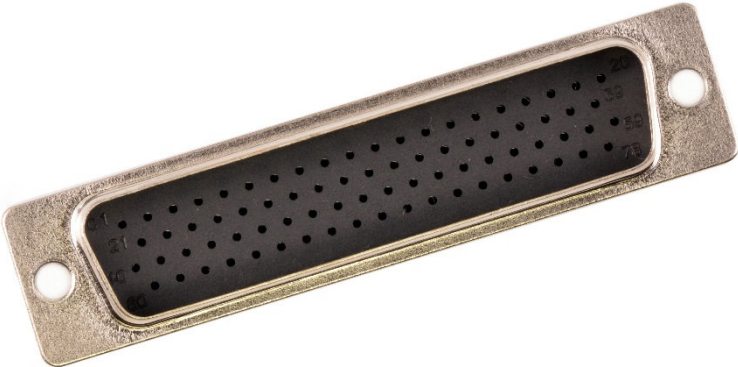

Crimp Connectors

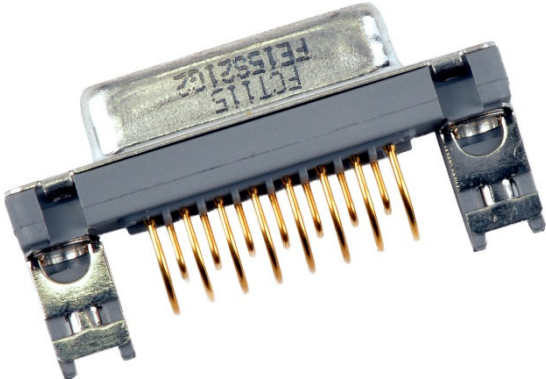

Low Profile – D-Sub

Our Products

D-Sub Miniature Mixed Layout Connectors

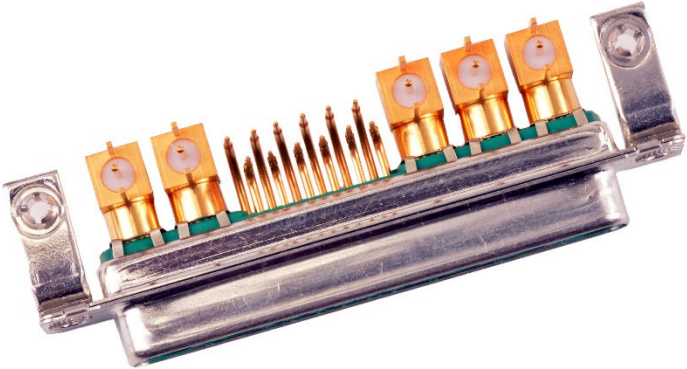
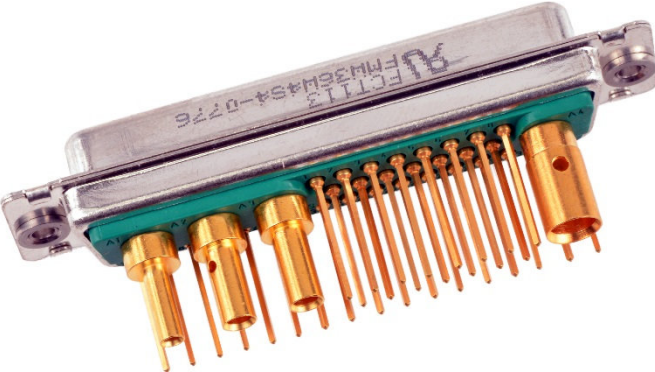
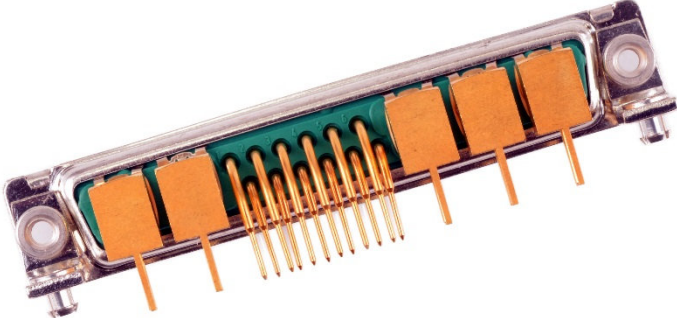
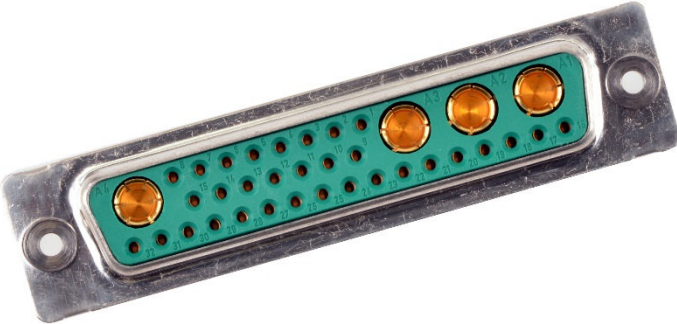

Our Products



Dualport Connectors

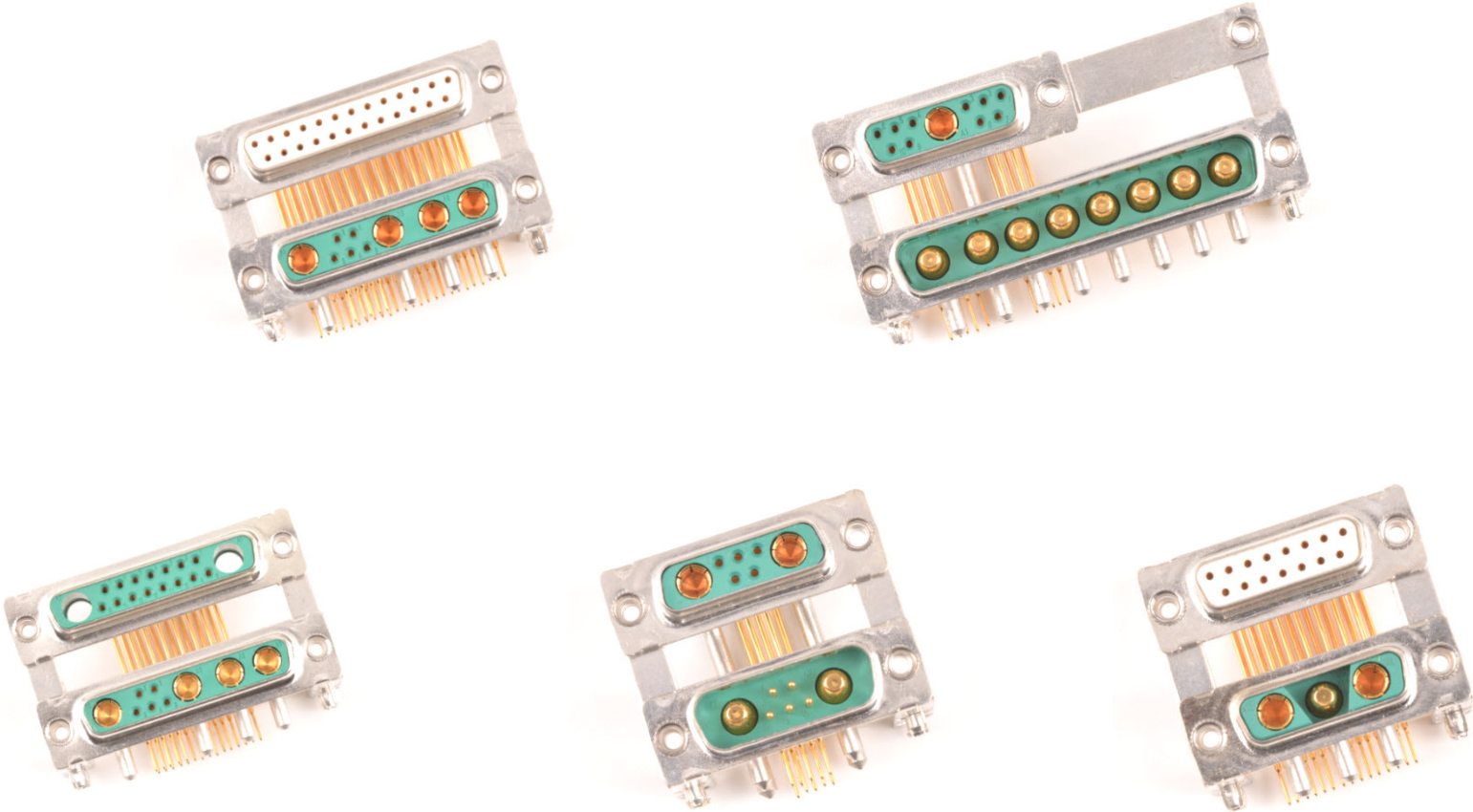

Our Products



D-Sub High Density Connectors

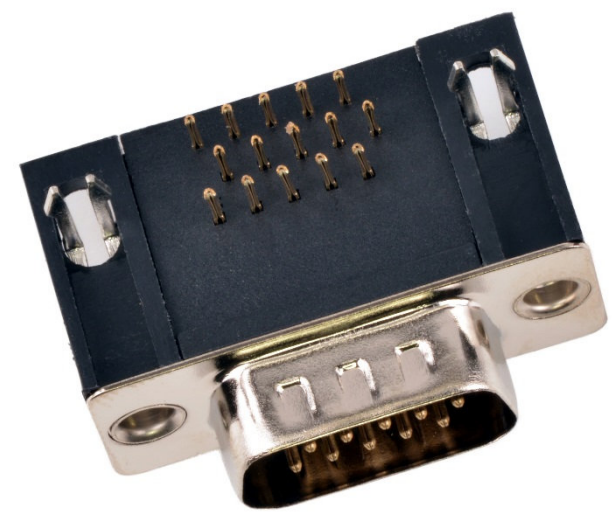
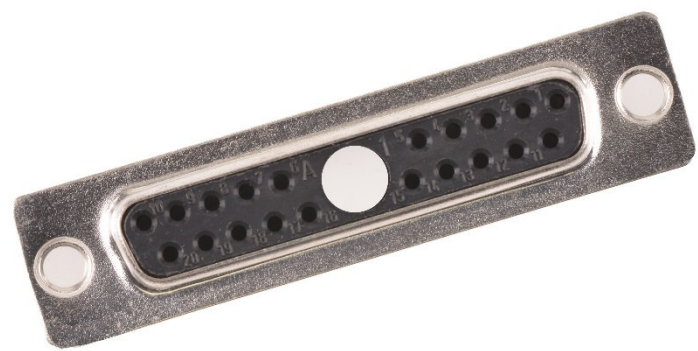

D-Sub High Filtered Connectors

EMV Protection

against surges, conducted disturbances, induced or electrostatic disturbances and suppressed conducted disturbance emissions

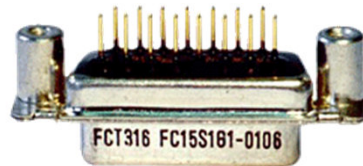

Advantages of FCT Filter Connectors

- Fully compatible
- Tin plated shells with dimples
- Minimal attenuation in the transmission band
- Ceramic or chip capacitors
- C-Filter (Low pass filter)
- Ground Plane for additional RF shielding available

FCT filter connector are the second to none solution for your EMI challenges



Available contact arrangements:

- All Mixed Layout contact arrangements are available
- 3W3 and 3W3PC available
- 2W2 planed

Other contact arrangements on request

Our Products

Connectors According EN 60603-2

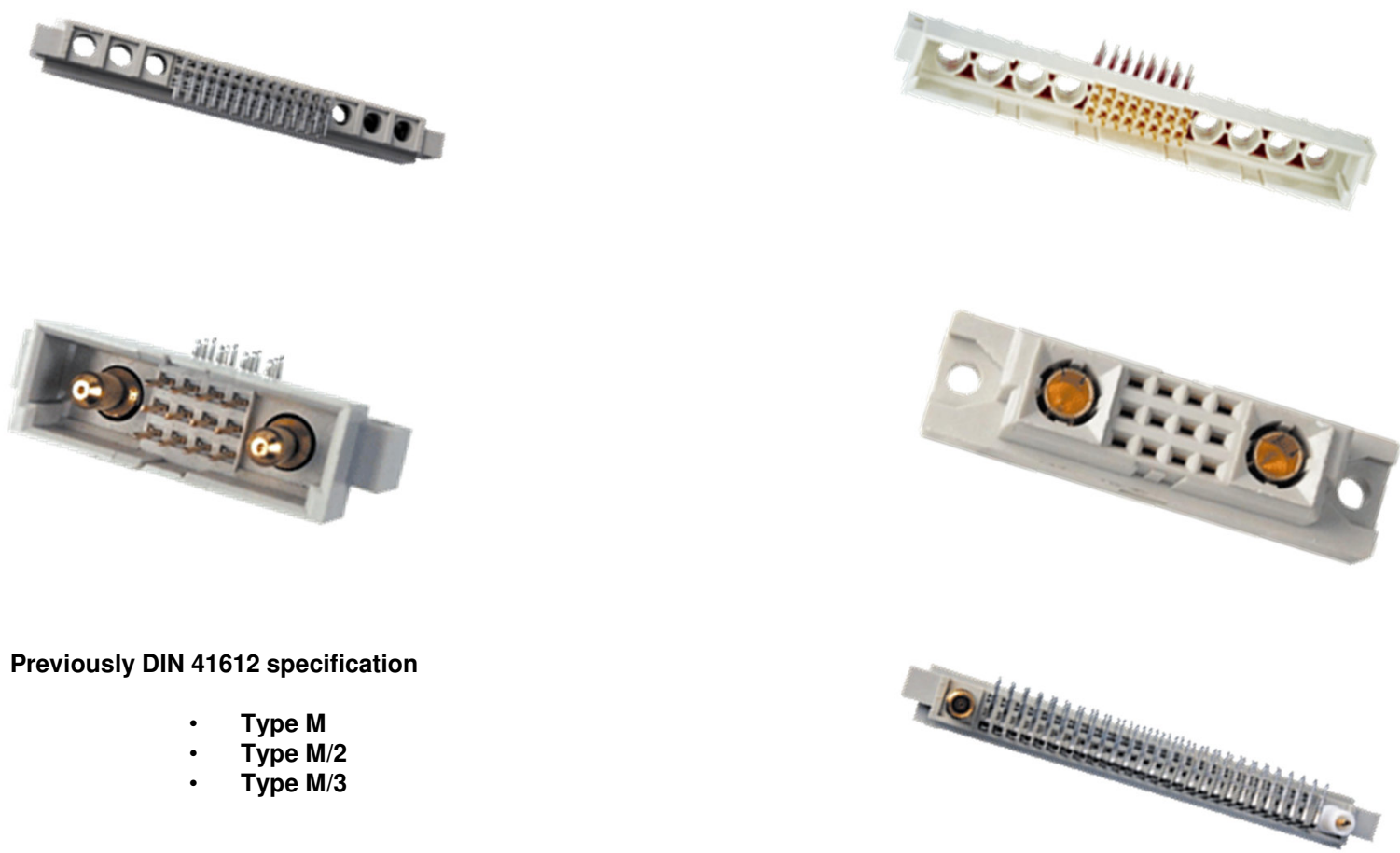

Previously DIN 41612 specification

- Type M
- Type M/2
- Type M/3

Our Products



Accessories

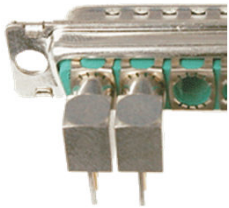

Grounding

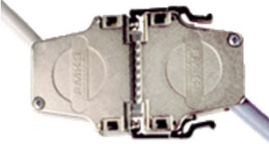

Latching Hardware



Dust Caps



Sealing Plugs



Guide Pin Plates

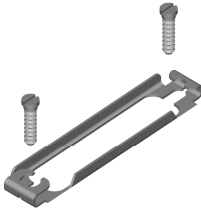

Slide Locks



Mating Hardware

Our Products

Features:

- Permeability $\mu_r \leq 1.0025$
- Accessories brass tin-plated
- Plastic hoods shell has standard hood material
- Metal hoods shell is zinc die-cast with special alloy
- 100% Permeability check

Available non-mag products:

- D-SUB standard, Mixed layout, Crimp connector
- RF contacts, high power contacts
- Metal hoods, plastic hoods

Applications:

- Medical industry (e.g. computer tomograph)
- Electron accelerator
- Measuring equipment
- etc.

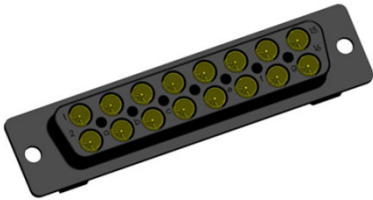
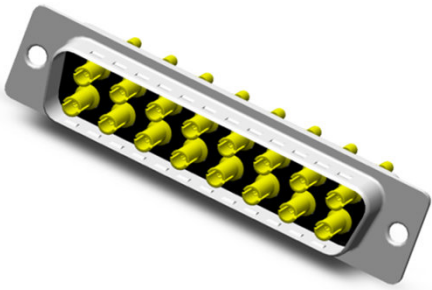
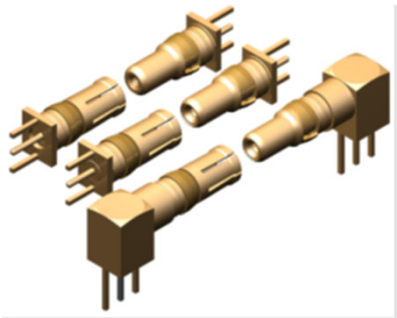
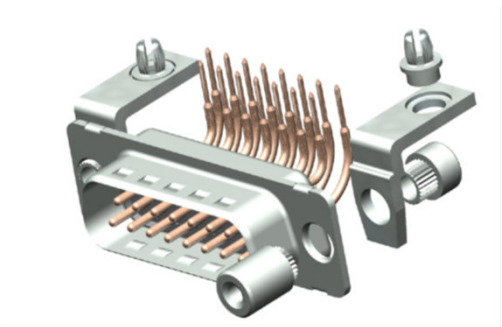

Our Products

High Power Contacts



Coaxial Contacts

